



RECORD OF SURVEY
 A PORTION OF SECTIONS 24 & 25,
 TOWNSHIP 19 NORTH, RANGE 16 EAST, W.M.,
 AND
 A PORTION OF SECTIONS 30 & 31,
 TOWNSHIP 19 NORTH, RANGE 17 EAST, W.M.,
 KITTITAS COUNTY, WASHINGTON

EXISTING LEGAL DESCRIPTION:
 KITTITAS COUNTY MAP NUMBERS:
 19-16-24020-0002 & 19-16-24030-0002

LEGEND

-  SECTION CORNER, AS NOTED
-  QUARTER CORNER, AS NOTED

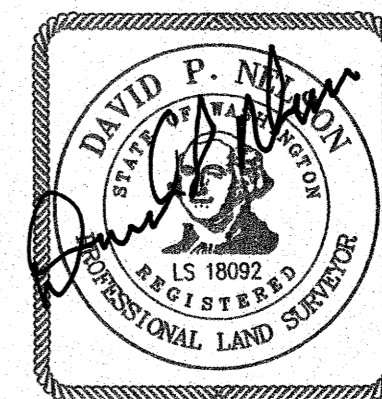

RECEIVED
 DEC 18 2012
 KITTITAS COUNTY
 CDS

INDEX LOCATION
 SEC. 24 T. 19 N. R. 16 E. W.M.

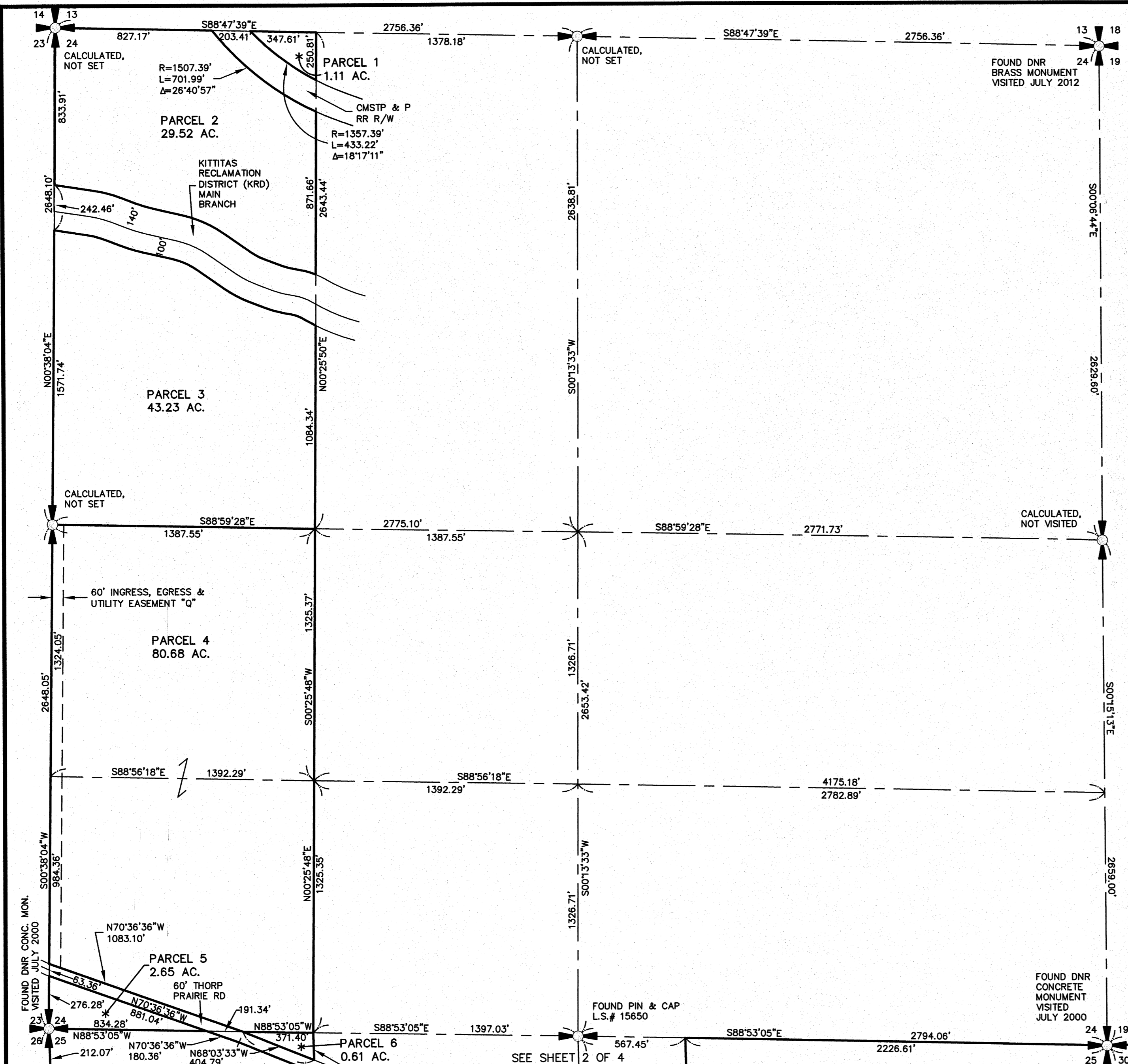
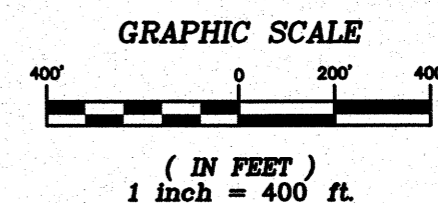
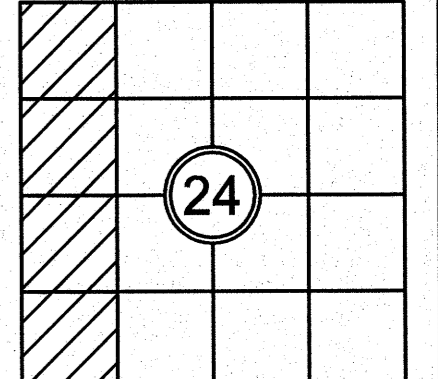

RECORDER'S CERTIFICATE 20121218 0052
 FILED FOR RECORD THIS 18 DAY OF DEC 2012 AT 4:41 P.M.
 IN BOOK 38 OF SURVEYS AT PAGE 121 AT THE REQUEST OF
DAVID P. NELSON
 SURVEYOR'S NAME
JERALD V. PETTIT
 County Auditor

SURVEYOR'S CERTIFICATE
 THIS MAP CORRECTLY REPRESENTS A SURVEY MADE BY ME OR UNDER MY
 DIRECTION IN CONFORMANCE WITH THE REQUIREMENTS OF THE SURVEY
 RECORDING ACT AT THE REQUEST OF THREE BAR G RANCH
 IN DEC. 2012
David P. Nelson
 DAVID P. NELSON DATE 12-18-2012
 CERTIFICATE NO. 18092

Encompass
 ENGINEERING & SURVEYING

Western Washington Division
 165 NE Juniper Street, Suite 201 • Issaquah, WA 98027 • Phone: (425) 392-0250 • Fax: (425) 391-3055
 Eastern Washington Division
 108 East 2nd Street • Cle Elum, WA 98922 • Phone: (509) 674-7433 • Fax: (509) 674-7419

SEGREGATION SURVEY		
PREPARED FOR THREE BAR G RANCH		
A PTN. OF SECTIONS 24 & 25, TWN. 19N., RGE. 16E., W.M. & A PTN. OF SECTIONS 30 & 31, TWN. 19N., RGE. 17E., W.M.		
KITTITAS COUNTY		WASHINGTON
DWN BY	DATE	JOB NO.
G. WEISER	12/2012	12116
CHKD BY	SCALE	SHEET
D. NELSON	1"=400'	1 OF 4

SEE SHEET 1 OF 4

RECORD OF SURVEY
 A PORTION OF SECTIONS 24 & 25,
 TOWNSHIP 19 NORTH, RANGE 16 EAST, W.M.,
 AND
 A PORTION OF SECTIONS 30 & 31,
 TOWNSHIP 19 NORTH, RANGE 17 EAST, W.M.,
 KITTITAS COUNTY, WASHINGTON

EXISTING LEGAL DESCRIPTION:

KITTITAS COUNTY MAP NUMBERS:

19-16-25010-0001, 19-16-25020-0008,
 19-16-25020-0009 & 19-16-25030-0001

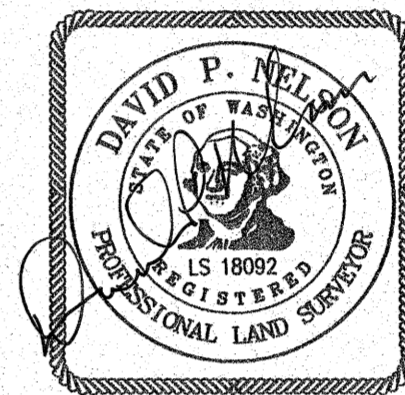

RECEIVED

DEC 18 2012

KITTITAS COUNTY
 CDS

INDEX LOCATION
 SEC. 25 T. 19 N.R. 16 E. W.M.

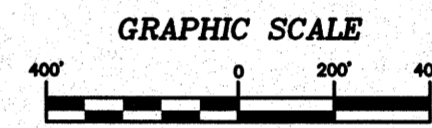
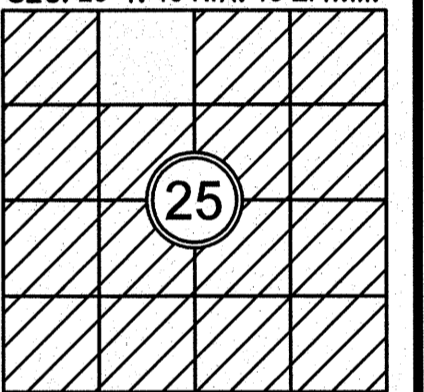

(IN FEET)
 1 inch = 400 ft.

SEE SHEET 3 OF 4

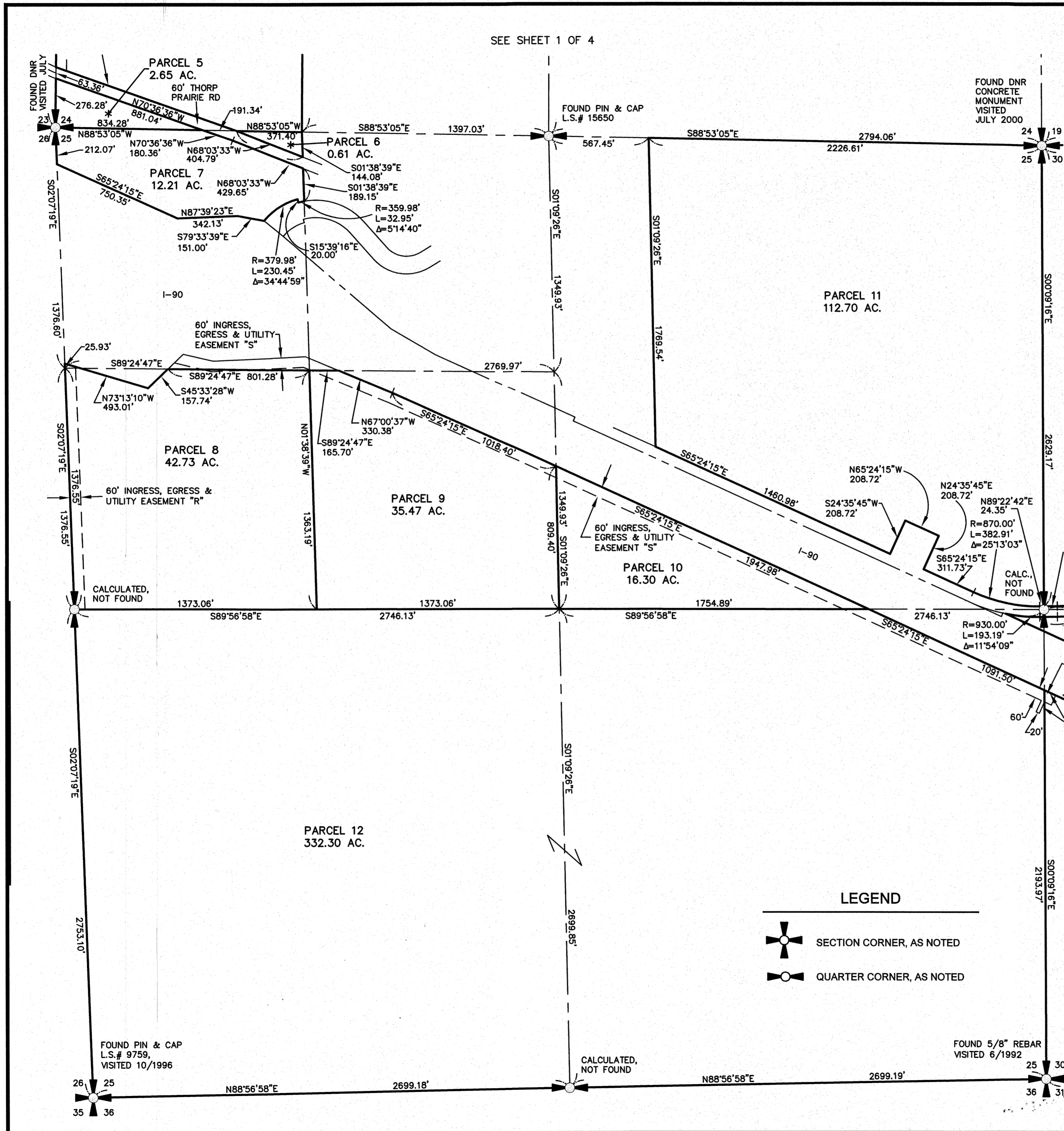

LEGEND

- SECTION CORNER, AS NOTED
- QUARTER CORNER, AS NOTED

RECORDER'S CERTIFICATE <u>2012180052</u>		
Filed for record this <u>18</u> day of <u>Dec</u> , 2012, at <u>4:41 P.M.</u> in book <u>30</u> of <u>SURVEYS</u> , at page <u>122</u> , at the request of <u>DAVID P. NELSON</u> Surveyor's Name		
<u>Arnold Pettit</u> County Auditor	<u>K. Weiser</u> Deputy County Auditor	
SURVEYOR'S CERTIFICATE		
This map correctly represents a survey made by me or under my direction in conformance with the requirements of the Survey Recording Act at the request of <u>THREE BAR G RANCH</u> in <u>DEC</u> , 20 <u>12</u> .		
<u>David P. Nelson</u> DAVID P. NELSON		DATE
		Certificate No. <u>18092</u>
Encompass ENGINEERING & SURVEYING		
<small>Western Washington Division 165 NE Juniper Street, Suite 201 • Issaquah, WA 98027 • Phone: (425) 392-0250 • Fax: (425) 391-3055 Eastern Washington Division 108 East 2nd Street • Cle Elum, WA 98922 • Phone: (509) 674-7433 • Fax: (509) 674-7419</small>		
SEGREGATION SURVEY		
PREPARED FOR THREE BAR G RANCH		
A PTN. OF SECTIONS 24 & 25, TWN. 19N., RGE. 16E., W.M. & A PTN. OF SECTIONS 30 & 31, TWN. 19N., RGE. 17E., W.M. KITTITAS COUNTY WASHINGTON		
DWN BY G. WEISER	DATE 12/2012	JOB NO. 12116
CHKD BY D. NELSON	SCALE 1"=400'	SHEET 2 OF 4

RECORD OF SURVEY
 A PORTION OF SECTIONS 24 & 25,
 TOWNSHIP 19 NORTH, RANGE 16 EAST, W.M.,
 AND
 A PORTION OF SECTIONS 30 & 31,
 TOWNSHIP 19 NORTH, RANGE 17 EAST, W.M.,
 KITTITAS COUNTY, WASHINGTON

RECEIVED

DEC 18 2012

KITTITAS COUNTY
CDS

EXISTING LEGAL DESCRIPTION:

KITTITAS COUNTY MAP NUMBERS:

19-17-30010-0001, 19-17-30020-0001,
 19-17-30020-0002, 19-17-30030-0001,
 19-17-30040-0002 & 19-17-30040-0003

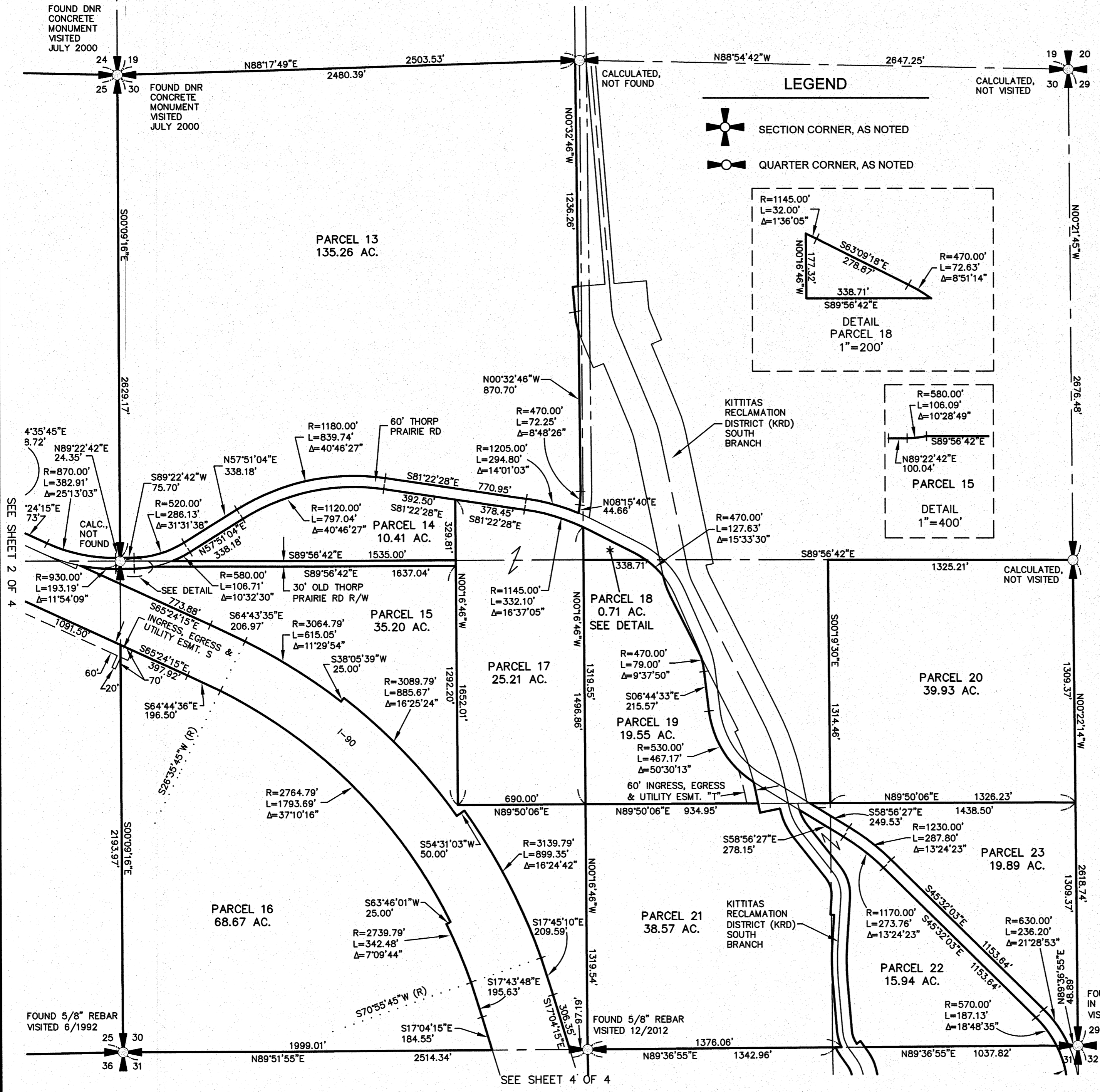
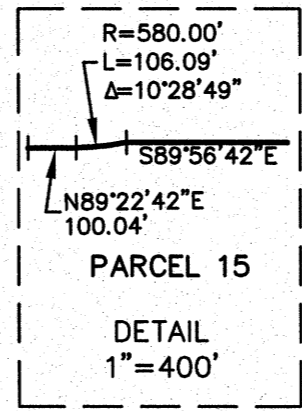
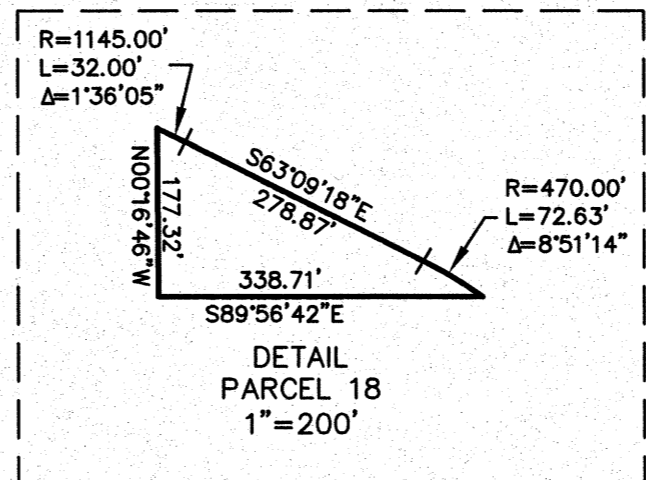
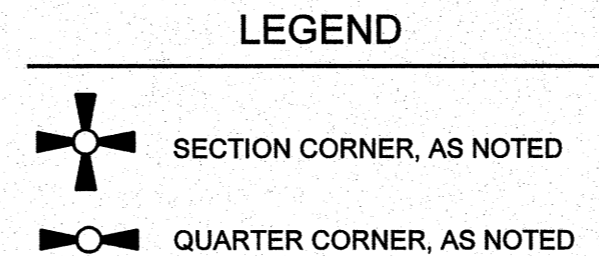
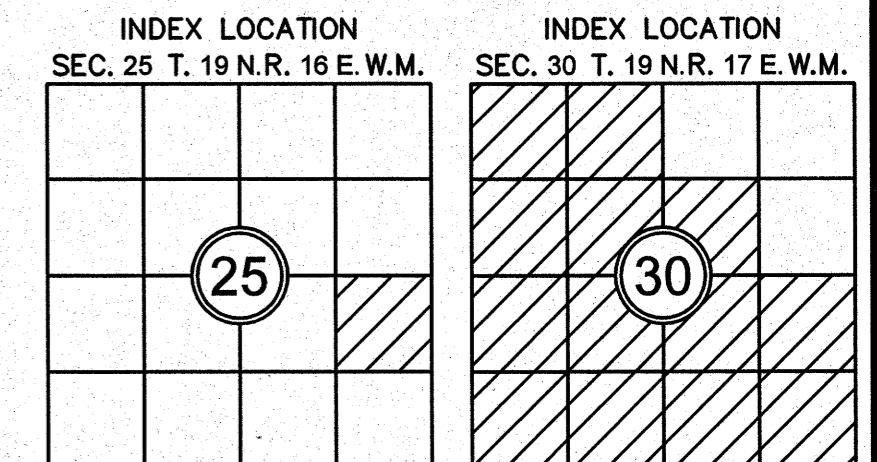
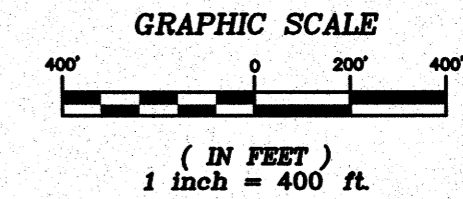
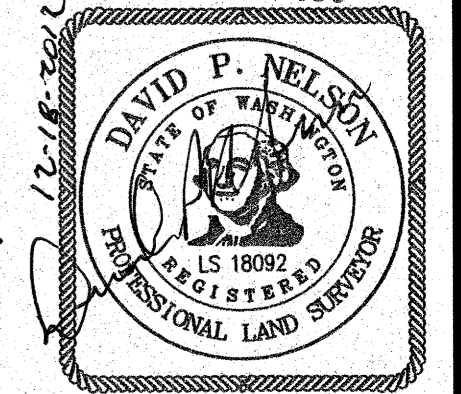

RECORDER'S CERTIFICATE 201212180052
 Filed for record this 18 day of DEC, 2012 at 4:41 AM
 in book 38 of Surveys at page 123 at the request of
DAVID P. NELSON
 Surveyor's Name
Jared Pettit County Auditor David Nelson Deputy County Auditor

SURVEYOR'S CERTIFICATE

This map correctly represents a survey made by me or under my direction in conformance with the requirements of the Survey Recording Act at the request of THREE BAR G RANCH in DEC, 2012.

David P. Nelson 12-18-2012
 DAVID P. NELSON DATE
 Certificate No. 18092

Encompass
 ENGINEERING & SURVEYING

Western Washington Division
 165 NE Juniper Street, Suite 201 • Issaquah, WA 98027 • Phone: (425) 392-0250 • Fax: (425) 391-3055
 Eastern Washington Division
 108 East 2nd Street • Cle Elum, WA 98922 • Phone: (509) 674-7433 • Fax: (509) 674-7419

SEGREGATION SURVEY
 PREPARED FOR
THREE BAR G RANCH
 A PTN. OF SECTIONS 24 & 25, TWN. 19N., RGE. 16E., W.M. &
 A PTN. OF SECTIONS 30 & 31, TWN. 19N., RGE. 17E., W.M.
 KITTITAS COUNTY WASHINGTON

DWN BY	DATE	JOB NO.
G. WEISER	12/2012	12116
CHKD BY	SCALE	SHEET
D. NELSON	1"=400'	3 OF 4

RECORD OF SURVEY
A PORTION OF SECTIONS 24 & 25,
TOWNSHIP 19 NORTH, RANGE 16 EAST, W.M.,
AND
A PORTION OF SECTIONS 30 & 31,
TOWNSHIP 19 NORTH, RANGE 17 EAST, W.M.,
KITTITAS COUNTY, WASHINGTON

SEE SHEET 3 OF 4

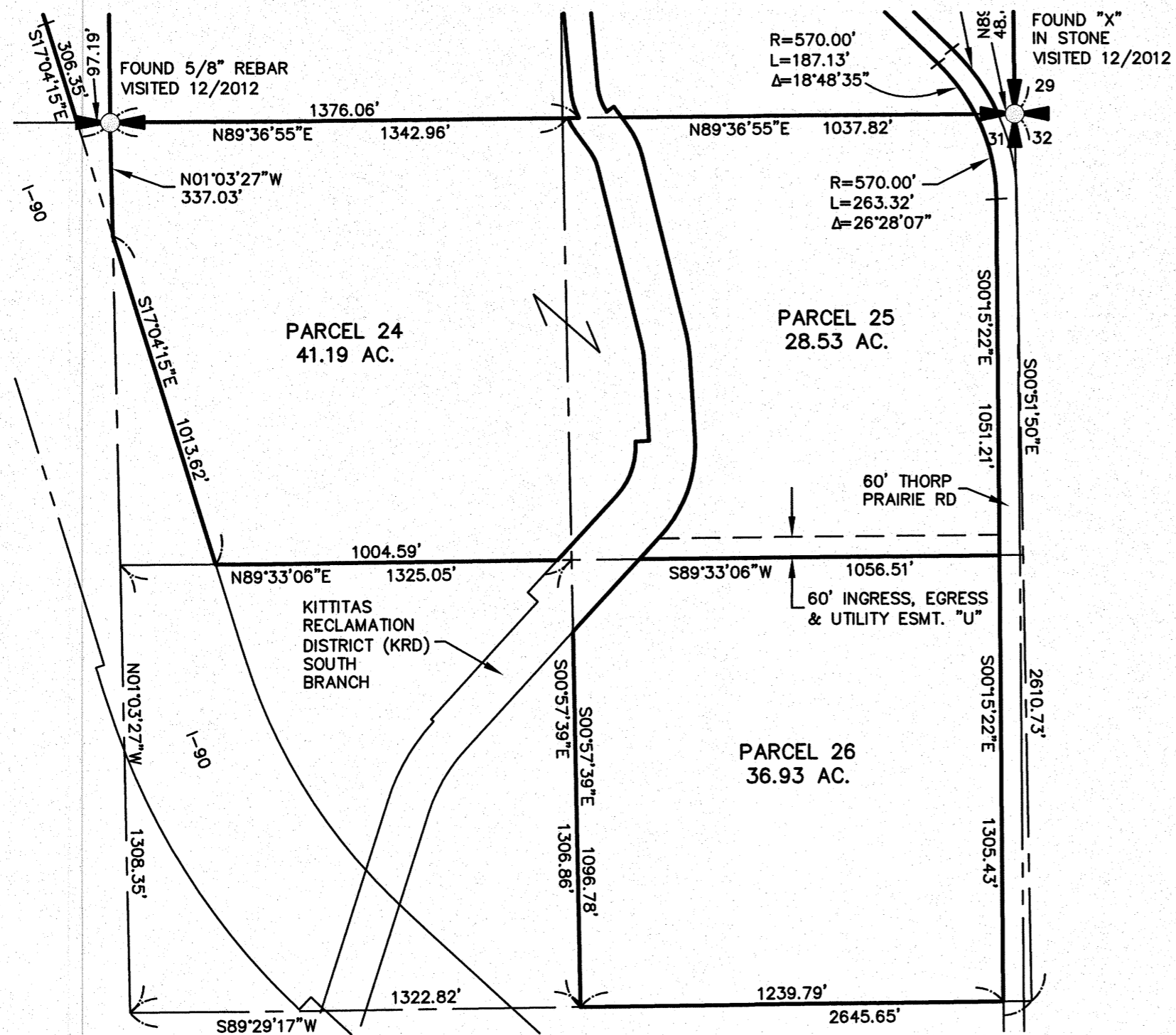

EXISTING LEGAL DESCRIPTION:

KITTITAS COUNTY MAP NUMBERS:
 19-17-31010-0001 & 19-17-31010-0003



NOTES:

- THE PURPOSE OF THIS SURVEY IS TO SEGREGATE THE SUBJECT PROPERTY BY USING INTERVENING OWNERSHIP AS SHOWN PURSUANT TO KITTITAS COUNTY CODE 16.08.015.
- THIS SURVEY WAS PERFORMED WITHOUT THE BENEFIT OF A CURRENT TITLE REPORT. THEREFORE, IT DOES NOT PURPORT TO SHOW ALL EASEMENTS, ENCUMBRANCES OR RESTRICTIONS OF RECORD OR OTHERWISE.
- FOR ADDITIONAL SURVEY INFORMATION AND SECTION CORNER DOCUMENTATION, SEE THE FOLLOWING:
 - BOOK 34 OF SURVEYS, PAGE 27, AFN: 200704300086
 - BOOK 23 OF SURVEYS, PAGES 191 & 192, AFN: 199808170006
 - BOOK 27 OF SURVEYS, PAGES 194-200, AFN: 200206280010
 - BOOK E OF SHORT PLATS, PAGES 104 & 105, AFN: 199611050027
- AND THE SURVEYS REFERENCED THEREON, ALL RECORDS OF KITTITAS COUNTY, STATE OF WASHINGTON.
- THE BASIS OF BEARINGS IS WASHINGTON STATE PLANE COORDINATE SYSTEM.
- THIS SURVEY WAS PERFORMED USING A TRIMBLE R8 GPS. THE CONTROLLING MONUMENTS AND PROPERTY CORNERS SHOWN HEREON WERE LOCATED AND CHECKED FROM A CLOSED FIELD TRAVERSE IN EXCESS OF 1:10,000 LINEAR CLOSURE AFTER AZIMUTH ADJUSTMENT.
- THE LOCATION OF THE KITTITAS RECLAMATION DISTRICT CANAL RIGHT OF WAY IS BASED ON THE KITTITAS RECLAMATION DISTRICT (KRD) RIGHT OF WAY MAPS LOCATED IN THE KITTITAS COUNTY DEPARTMENT OF PUBLIC WORKS OFFICE.
- THE LOCATION OF THE THORP PRAIRIE ROAD IS BASED ON THE ACTUAL FIELD LOCATION IN DECEMBER 2012.
- THE LOCATION OF INTERSTATE 90 (I-90) IS BASED ON THE ACTUAL FIELD SURVEY OF MONUMENTS IN DECEMBER OF 2012.
- THIS SURVEY WAS PERFORMED WITHOUT THE BENEFIT OF A CURRENT TITLE REPORT. THEREFORE, IT DOES NOT PURPORT TO SHOW ALL EASEMENTS, ENCUMBRANCES OR RESTRICTIONS OF RECORD OR OTHERWISE.

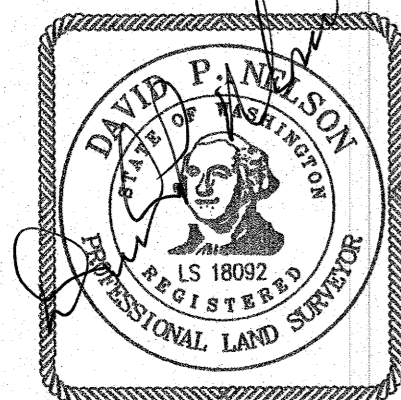
RECEIVED
 DEC 18 2012
 KITTITAS COUNTY
 CDS



LEGEND

-  SECTION CORNER, AS NOTED
-  QUARTER CORNER, AS NOTED

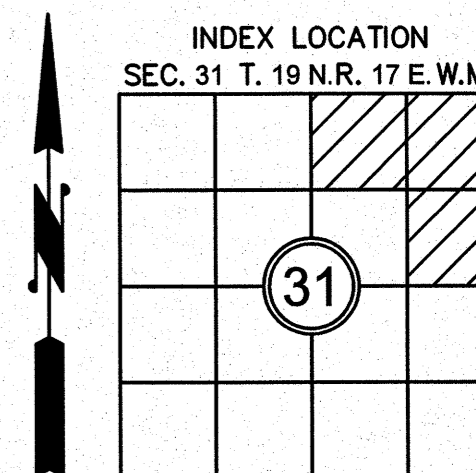
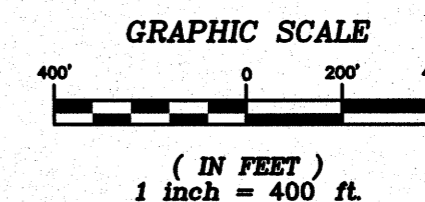

RECORDER'S CERTIFICATE 201212180052

FILED FOR RECORD THIS 18 DAY OF DEC 2012 AT 4:41 P.
 IN BOOK 38 OF SURVEYS AT PAGE 124 AT THE REQUEST OF

DAVID P. NELSON
 SURVEYOR'S NAME
JERALD V. PETTIT
 County Auditor

SURVEYOR'S CERTIFICATE

THIS MAP CORRECTLY REPRESENTS A SURVEY MADE BY ME OR UNDER MY DIRECTION IN CONFORMANCE WITH THE REQUIREMENTS OF THE SURVEY RECORDING ACT AT THE REQUEST OF THREE BAR G RANCH
 IN DEC. 2012

DAVID P. NELSON DATE
 CERTIFICATE NO. 18092

Encompass
 ENGINEERING & SURVEYING

Western Washington Division
 165 NE Juniper Street, Suite 201 • Issaquah, WA 98027 • Phone: (425) 392-0250 • Fax: (425) 391-3055
 Eastern Washington Division
 108 East 2nd Street • Cle Elum, WA 98922 • Phone: (509) 674-7433 • Fax: (509) 674-7419

SEGREGATION SURVEY

PREPARED FOR
 THREE BAR G RANCH
 A PTN. OF SECTIONS 24 & 25, TWN. 19N., RGE. 16E., W.M. &
 A PTN. OF SECTIONS 30 & 31, TWN. 19N., RGE. 17E., W.M.

KITTITAS COUNTY		WASHINGTON	
DWN BY	DATE	JOB NO.	
G. WEISER	12/2012	12116	
CHKD BY	SCALE	SHEET	
D. NELSON	1"=400'	4 OF 4	